



SOLAR AC DC

JUST COMMON SENSE



Photovoltaic AC/DC Ducted Air Conditioner Installation Manual

Table of contents

Contents

Table of contents	1
Table of Revisions	2
Model Applicability	2
Equipment description	3
Standards reference	4
Disclaimer	4
Symbols used.	4
.....	5
Warning	5
Safety Precautions.....	5
Dimensions	6
Air Outlet Dimensions	7
Air Inlet Dimensions	7
Indoor unit mounting	7
Outdoor unit mounting Instructions.....	9
Outdoor unit required clearances.	9
Refrigerant pipe Specifications	10
Refrigerant fill capacity	10
Maximum Length of piping.....	10
Addition of refrigerant per pipe length.....	11
Connecting the Refrigerant piping	11
Pressure Testing the System.....	12
Evacuate the System.....	12
Releasing the refrigerant into the system	13
Electrical Connections	13
.....	14
Installation of Solar Modules.....	14
Solar Array Maximum Voltage.	15
.....	15
Galvanic considerations outdoor unit.	15
Solar Module installation.....	15
Solar Arrays in Parallel	16
Solar Array maximum current	16
Solar Array Mechanical installation.....	18
Earth Fault Protection Solar DC	21
Signage.....	21
Solar Disclaimer.....	22

Electrical and Gas Leak checks.....	23
Gas Leak checks	23
Electrical Safety checks	23
Maintenance	24
Operating Instructions.....	25
.....	25
Wired Control operation.....	26
Detailed Wired Control operation	27
Timing Periods	29
AC Limiting Mode note:.....	29
AC Limiter Mode Permanent setting	30
Fault Display	30
Android or I phone app.....	31
Troubleshooting and Repair	32
Common Issues.....	32
AC/DC Booster Error Code	35
Error Code list	36

Table of Revisions

Table of Revisions		
Revision Date	Reason for revision	Revision By
25 July 2021	Initial writing	George Abernathy

Model Applicability

This manual applies to the following models:

Table of Models		
Model	DLMDWA1-ACDC-18K	DLDMWA1-ACDC-24K
Indoor unit	DLMDA1-ACDC-18K	DLMDA1-ACDC-24K
Outdoor unit	DLWB1-ACDC-18K	DLWB1-ACDC-24K

Equipment description

The equipment consists of an indoor unit and an outdoor unit air conditioning system. The system produces heating or cooling as required.

The system can be powered in several ways.

- By DC solar alone. It will start up and run on just the solar
- By DC solar and mixed amount of AC 240 Volt power.
- By AC 240 Volt only. This would be applicable at night.

Installation is the same as a standard ducted air conditioner with the addition of Solar PV modules to supply the DC input.

The system is controlled by a wired controller or by WIFI.

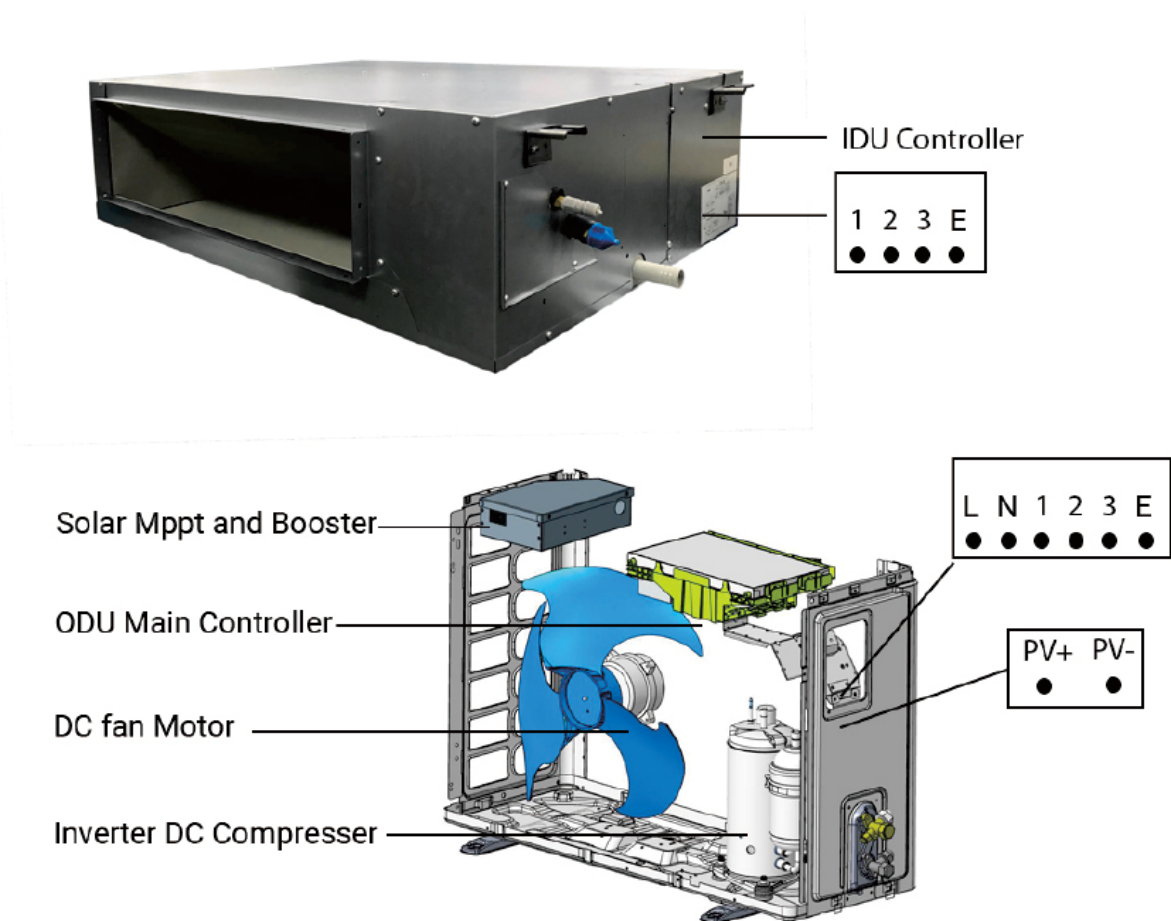

Standards reference

The standards listed here may not be all applicable standards. Check local and national standards for additional applicability. Check for the latest revisions and clauses.

Standards
AS/NZS 1319
AS/NZS 1571
AS/ NZS 3000
As/ NZS 3500
AS/NZS 4777
AS/NZS 5033
AS/NZS 5149
IEC 62109
National construction code volume 3 plumbing code of Australia.
Australia and New Zealand Refrigerant Handling code of practice part 2

Disclaimer

This equipment requires the handling and installation of High-pressure gasses, and hazardous levels of AC and DC voltages. Only fully qualified licenced personnel may install this equipment.

Personal Protection Equipment (PPE) must be used while installing this equipment. Care must be taken that all required PPE and precautions are taken. The manufacturer and resellers of this equipment assume no responsibility for any failure to properly protect personnel. Any recommendations are only for advisory purposes.

The references to standards in this manual are advisory. Failure to follow all applicable standards will void the equipment warranty.

All Electrical work must be performed by a licenced technician according to local regulations and the instructions given in this manual.

The illustrations in this manual are for explanatory purposes. The actual shape of your units may be slightly different.

Symbols used.



General Warnings beware of a hazard and take preventative measures.



Freezing and frost bite, beware escaping refrigerant and take preventative measures.



High voltage or Electric Shock. Make certain that all electrical circuits are not energized



Explosion risk, High pressure gasses used in testing and operation.



High pressure gas bottle



Caution risk of electric shock



Warning

Safety Precautions

- All Electrical work must be performed by a licenced technician according to local regulations and the instructions given in this manual.
- Installation must be performed by an authorized dealer or specialist. Defective installation can cause water leakage, electrical shock, or fire.
- Before installing, modifying, or servicing this appliance, the main electrical disconnect switch must be in the OFF position. There may be more than one disconnection switch. Lock out and tag with a suitable warning label.
- Never supply power to the unit unless all wiring and tubing are completed, re-connected and checked.
- This system has hazardous electrical voltages. Ensure that all wiring is compliant with this manual and local regulations.
- The unit and the solar system must be earthed in accordance with local electrical and building codes.
- Compatible MC4 type connectors must be used.
- Do not allow children to play with the air conditioner. Children must always be supervised around the unit.
- Contact an authorized service technician for repair or maintenance of this unit.
- Only use the included accessories, parts, and specified parts for installation. Using non-standard parts can cause water leakage, electrical shock, fire, and can cause the unit to fail.
- Install the unit in a firm location that can support the unit's weight. If the chosen location cannot support the unit's weight, or the installation is not done properly the unit may fall and cause serious injury and damage.
- For all electrical work, follow all local and national wiring standards, regulations, and the Installation manual.
- The unit must be powered by a dedicated circuit with a residual current and leakage device.
- For all electrical work, use the specified cables. Connect cables properly and clamp them securely to prevent external forces from damaging the electrical connections. Improper electrical connections can overheat and cause fire and may also cause electric shock.
- All wiring must be properly arranged to ensure that control board cover can close properly. If the control board cover is not closed properly, it can lead to corrosion and

cause the connection points on the terminal strip to heat up, catch fire or cause electrical shock.

- In certain functional environments, such as kitchens, server rooms, etc., the use of specially designed air-conditioning units is highly recommended.
- For units that have an auxiliary electric heater, do not install the unit within 1 meter of any combustible materials.
- Do not install the unit in a location that may be exposed to combustible gas leaks. If combustible gas accumulates around the unit, it may cause fire.
- Do not install this air conditioner in a wet location such as a bathroom or laundry room. Too much exposure to water can cause electrical components to short circuit.
- This product must be properly earthed and installed with an earth leakage circuit breaker. Failure to do so may result in injury, electric shock, or death.
- Install drainage piping in accordance with local and national regulations and meet the requirements of the National construction code volume 3 plumbing code of Australia.
- This air-conditioning unit contains fluorinated gasses. For specific information on the type of gas please refer to the label(s) on the outdoor unit.
- De-commissioning and disposal of this unit must be performed by a certified technician, in accordance with the Australian and New Zealand Refrigerant Handling code of practice.
- When the unit is checked for leaks, proper record-keeping of all checks is strongly recommended.

Dimensions

Indoor unit

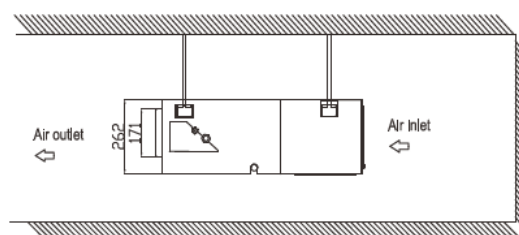
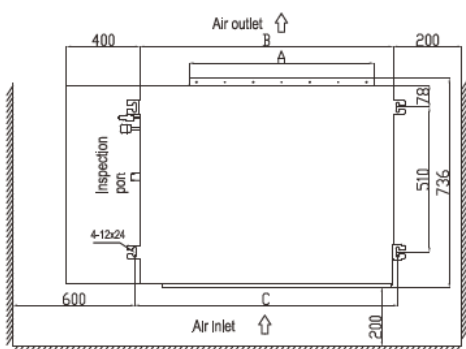

Type	A	B	C
18,000btu/5kw	650	890	930
24,000btu/7kw	650	890	930

Air Outlet Dimensions

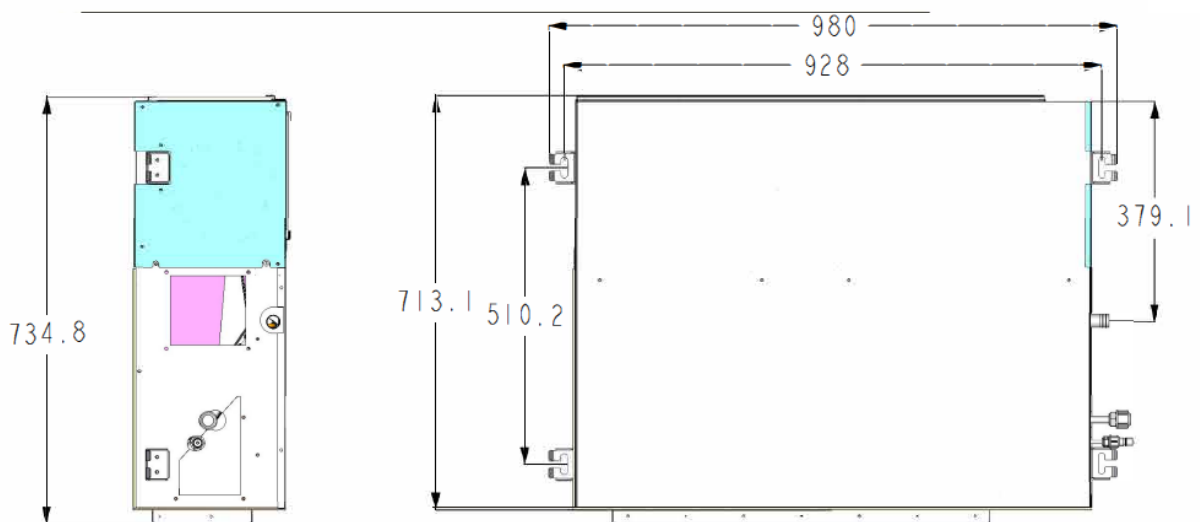

Air Inlet Dimensions

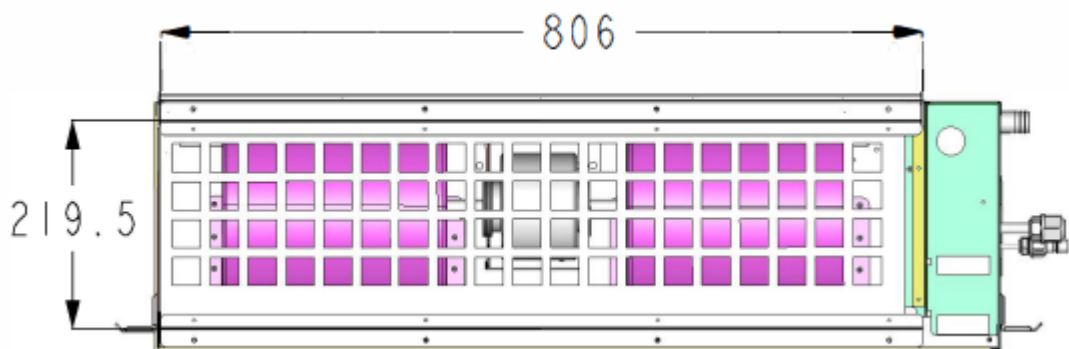

Indoor unit mounting

Prior to installation:

Before installing the indoor unit, refer to the label on the product box to make sure that the model number of the indoor unit matches the model number of the outdoor unit.

Before installing the indoor unit, you must choose an appropriate location. The following list will help you choose an appropriate location for the unit.

- Proper installation locations meet the following:
- Adequate support and mounting.
- Sufficient clearances for ducting and bends
- Convenient drainage
- At least one meter from all other electrical devices (e.g., TV radio, computer)

Do not install the unit in the following locations:

- Near any source of heat, steam, or combustible gas
- Near flammable items such as curtains or clothing



The indoor unit contains a pre-charge of inert gas. Take care when bending tubing and discharging this gas.



Select the location for the indoor unit. Check that the location is suitable for pipe penetration. Check that no wiring or piping will be affected by the pipe penetration location.

Use a stud finder to locate studs to prevent unnecessary damage. Each pipe must be insulated separately.

The indoor unit requires the following clearances.

Indoor unit clearances	
Above	50 mm
Left Side	400 mm
Right side	200 mm
Below	50 mm

Mount the unit so that it slopes 10 mm towards the drain fitting.

■ Duct and drain pipe installation

There are two installation methods of duct, as follows.

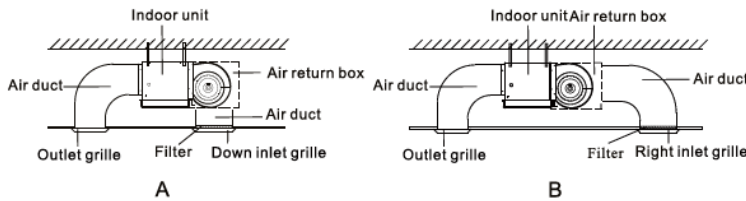

- Use canvas to connect the indoor unit and duct in order to reduce unnecessary vibration.
- As shown, the indoor unit should be leaning to the drain hole to be convenient for drainage.

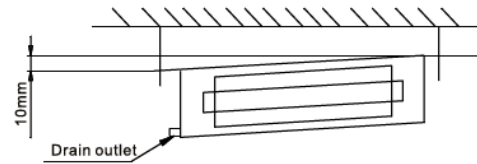

★ Installation of drainage pipe

1. The drain pipe must have a downward gradient (1/50 ~ 1/100).
If the drain pipe is installed ups and downs or upward, it will lead to water backflow or leakage etc.
2. During pipe connection, do not use too much force to the drain joint of indoor unit.
3. The joint is PT1.
4. There is a drain hole on each side of indoor unit; unused drain pipe must be closed.

Note: The drain pipe must be wrapped heat insulation material, otherwise it will cause condensation or water drops.

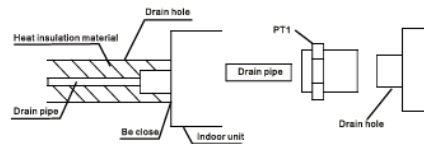
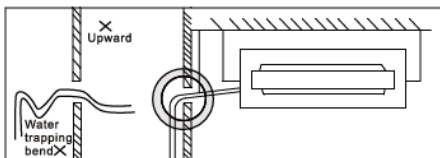

Pipe insulation to be separate and thickness of 8 mm foam minimum.



The air inlet filter box and filter area must be the same as or larger than the outlet ducting. If the inlet is restricted fan failure may result and warranty is void.

Outdoor unit mounting Instructions.

Install the condensate drain if required. The outdoor unit will condense water when the system is in heating mode. Consult local regulations for drainage connections.

Mount the unit on an approved wall mounting bracket and secure or mount the unit on a secure waterproof surface and secure.

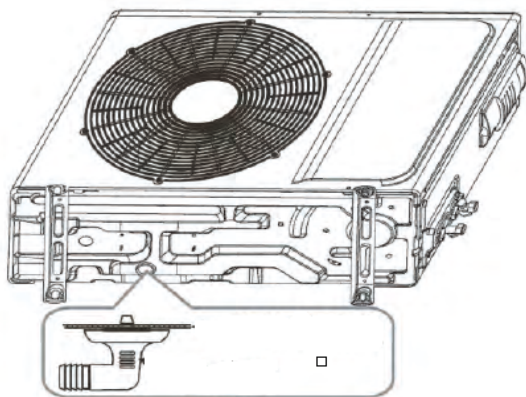

Outdoor unit required clearances.

Outdoor unit Clearances	
Above	500 mm
Left	300 mm
Right	60 mm
Below	200 mm
Behind	300 mm

Select a location that allows for sufficient air flow, that is free of obstructions.

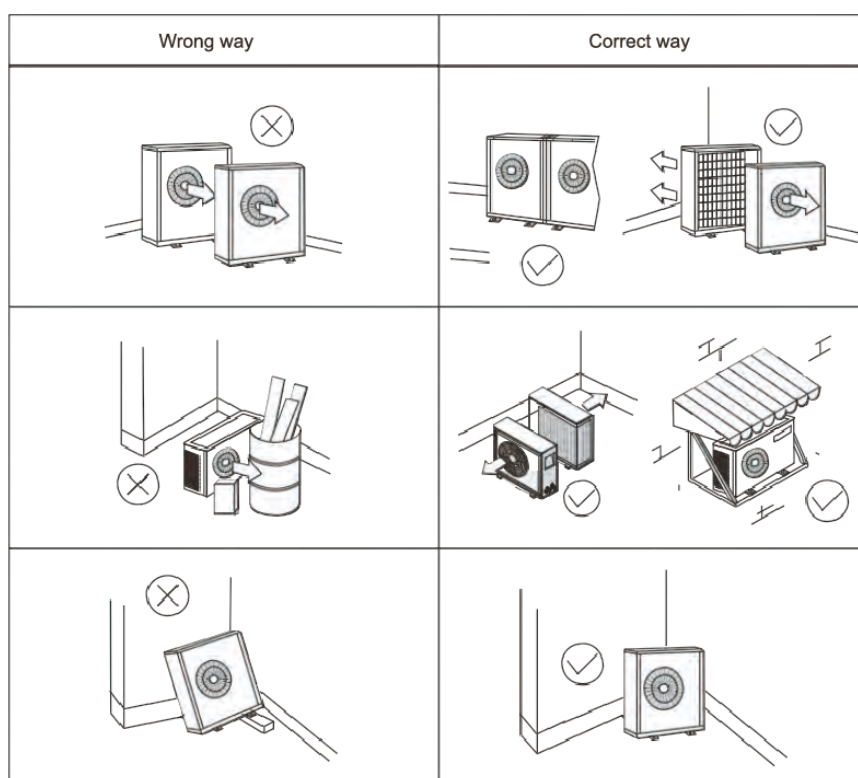

Refrigerant pipe Specifications

The system has a maximum ambient operating temperature of 58 degrees Celsius. The maximum pressure is 4300 Kpa / 623 Psig.

Piping must be specified in accordance with AS /NZS 1571. The minimum wall thickness is 0.81 mm for 6.35mm/1/4 inch to 12.7mm / ½ inch, and 0.91 for 15.88 mm / 5/8-inch tubing.

Refrigerant fill capacity

Refrigerant fill capacity charge volume and pressure			
Unit		DLMDWA1-ACDC-18K	DLMDWA1-ACDC-24K
Indoor unit		DLMDA1-ACDC-18K	DLMDA1-ACDC-24K
Outdoor unit		DLWA1-ACDC-18K	DLWB1-ACDC-24K
Refrigerant type		R410a	R410a
Charge Volume	g	1300	1600
Max Design pressure Discharge side	Kpa	4300	4300
Max design pressure Suction side	Kpa	1500	1500

Maximum Length of piping

Maximum pipe Length, Pipe sizes, Maximum head			
Unit		DLMDWA1-ACDC-18K	DLMDWA1-ACDC-24K
Indoor unit		DLMDA1-ACDC-18K	DLMDA1-ACDC-24K
Outdoor unit		DLWA1-ACDC-18K	DLWB1-ACDC-24K
Max pipe length	M	30	30
Pipe sizes	inch	1/4 & 1/2	1/4 & 1/2
Maximum Head (vertical)	M	15	15

Addition of refrigerant per pipe length

Pipe length more than 5 meters requires the addition of refrigerant.

Refrigerant to be added if pipe length is greater than 5 meters			
Unit		DLMDWA1-ACDC-18K	DLMDWA1-ACDC-24K
Indoor unit		DLMDA1-ACDC-18K	DLMDA1-ACDC-24K
Outdoor unit		DLWA1-ACDC-18K	DLWB1-ACDC-24K
Grams per meter	g	20	20

Connecting the Refrigerant piping



The indoor unit contains an inert gas. Use caution when loosening the flared fittings to vent the gas.

Cut the piping to length. Take care that no foreign matter enters the piping. Slide the flare nuts onto the piping. Flare the piping using a flaring tool for refrigerant piping.

Inspect the flares checking that they are even and do not have any cracks or burrs.

Flaring Torque specifications				
Pipe size	Torque	Flared width (A)	Flaring shape	Apply refrigerant oil or sealant
6mm / ¼ inch	15-18 Nm	8.3 / 8.7 mm		
9 mm / 3/8 inch	32-39 Nm	12.0 / 12.4 mm		
12 mm / ½ inch	49-59 Nm	15.4 / 15.8 mm		
15 mm / 5/8 inch	62-76 Nm	18.6 / 19.0 mm		
19 mm / ¾ inch	67-101 Nm	22.9 / 23.3 mm		

Remove the protective caps from the valves.

Align flared pipe ends with the valves and hand tighten.

Use a spanner to support the valve. (see illustration below)

While supporting the body of the valve use a torque wrench to tighten the nuts.

Repeat for the indoor unit connections.

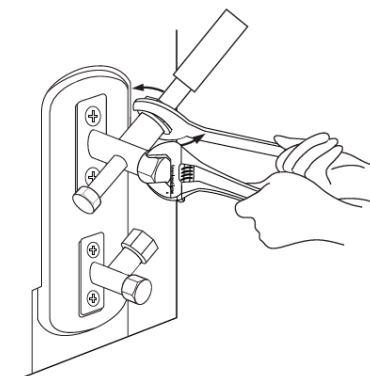

Pressure Testing the System



Fluorocarbons refrigerant must not be put into a system for the purposes of pressure leak testing. Australian refrigerant handling code of practice 5.29



High pressure nitrogen gas bottle handling. Wear appropriate PPE including eye, ear, protection, leather gloves.

Precautions:



Air and foreign matter in the refrigerant circuit can cause abnormal rises in pressure and could cause damage to the air conditioner. Care must be taken to ensure that the refrigerant lines are free of foreign matter.

Use Dry nitrogen for leak testing.

Pressurize the system to 3500 KPA/ 508 Psig and let stand for one hour. Note any pressure changes. The system must be observed over a period of one hour to ensure that no pressure drop occurs, having due regard to temperature variation throughout the system. Australian refrigerant handling code of practice 5.33

Evacuate the System.

Connect the low-pressure hose from the gauge set to the Low-pressure connection on the outdoor unit.

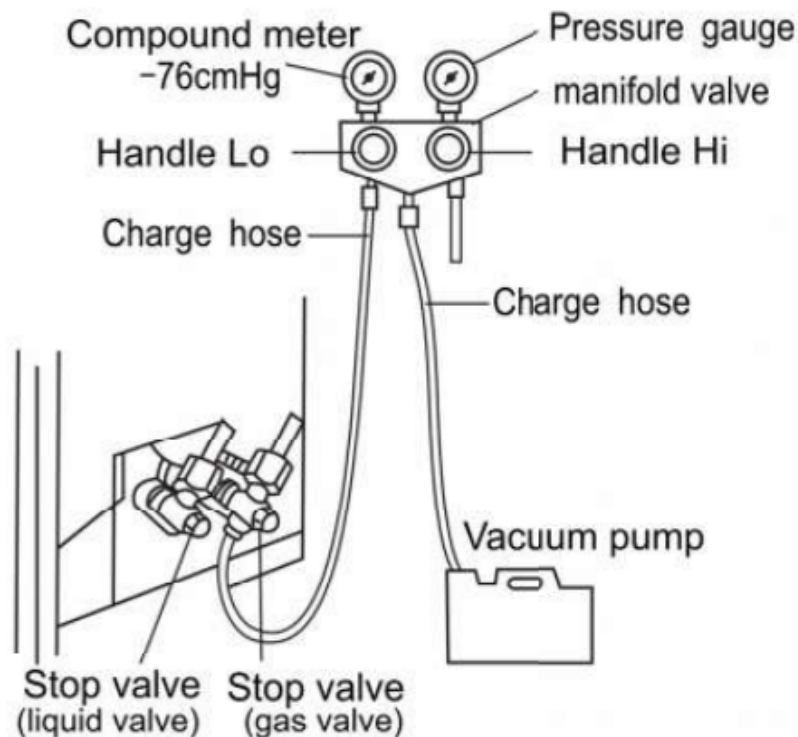

Vacuum the system down to 500 Microns of mercury. Allow the system to stand for one hour to detect leakage. A small rise may indicate water boiling off in the system. A large rise above 600 microns may indicate leakage in the piping. Australia and New Zealand refrigerant handling code of practice 6.4.

Releasing the refrigerant into the system

Check that the low-pressure hose is connected to the low-pressure side of the outdoor unit.

Check that the system has been evacuated to 500 microns. Remove the Vacuum micron gauge to prevent damage to it.

Open the low pressure and high-pressure valves by winding them out anti clockwise until seated.

The low-pressure gauge should read approximately 150 PSI.

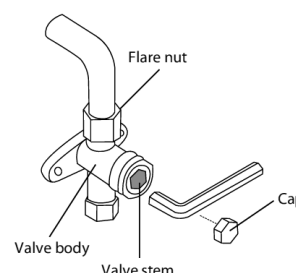

Electrical Connections

Maximum input power AC Circuit Breaker size DC input parameters			
Unit		DLDMWA1-ACDC 18K	DLDMWA1-ACDC-24K
Indoor unit		DLMDA1-ACDC-18K	DLMDA1-ACDC-24K
Outdoor unit		DLWA1-ACDC-18K	DLWB1-ACDC-24K
Power AC	Hz	1Ph 208V-240V/50-60HZ	1Ph 208V-240V/50-60HZ
Max input power	W	2500	3500
Circuit breaker RCBO Type A or B	A	16	20
Power DC	VDC	80-380	80-380
	ISC	</= 18 Adc	</= 18 Adc
DC MAX VOLTAGE	Voc	380	380
Max DC input current draw	A	12	12
Max number of arrays	#	2	2



Before performing electrical Work, Read these cautions.

- All wiring must comply with local and national electrical codes and regulations.
- All work must be accomplished by a licensed electrician.
- All electrical connections must be made according to the Electrical Connection Diagram.
- If there is a serious safety issue with the power supply, stop work immediately. Explain your reasoning to the client and refuse to install the unit until the safety issue is properly resolved.
- Power voltage should be within 90-100% pf rated voltage. Insufficient power supply can cause malfunction, electrical shock, or fire.
- Only connect the unit to an individual branch circuit. Do not connect another appliance to that outlet.
- The units must be properly earthed.

- All wiring must be properly connected. Loose wiring can cause failures and result in product malfunction and possible fire.
- Ensure that wires are not resting against refrigerant tubing, the compressor, or any moving parts within the unit.
- If the unit has an auxiliary electric heater, it must be installed at least one meter away from any combustible materials.



Before performing any electrical or wiring work, turn off the main power to the system.

Connect the cable from the indoor unit to the outdoor unit using a four-conductor cable.

Connect 240 Volt AC to a dedicated circuit from the Distribution board. Note the circuit breaker must provide Residual Current Device (RCD) protection per AS / NZS 3000 clause 2.6.3.2.3.3.

Note Per AS / NZS 3000 clause 4.19, the indoor and outdoor unit AC power must be isolated by an isolation switch adjacent to the outdoor unit.

Connect the solar DC to the dc connections provided via a solar isolator mounted adjacent to the outdoor unit.

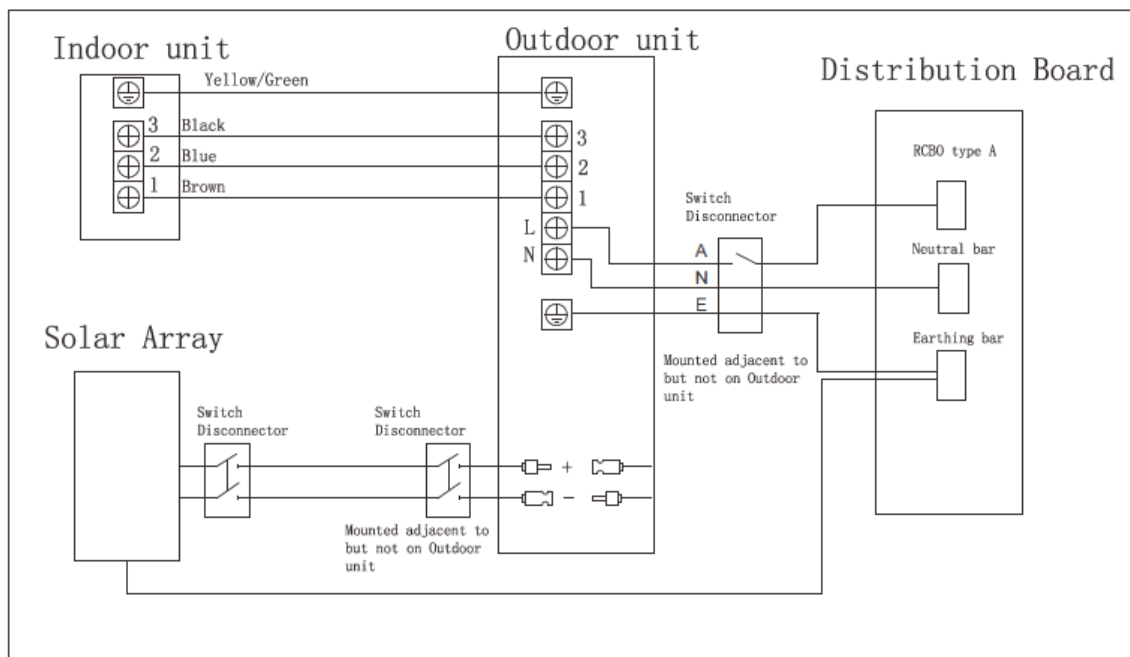

Installation of Solar Modules

Solar Modules must be installed in accordance with all applicable codes. Some of them are the local building codes, the Building Code of Australia, AS / NZS 4777 and AS / 5033. They must be installed by a licenced, competent person.

Solar Array Maximum Voltage.

The maximum Voltage Open Circuit (VOC) must be calculated to account for low temperature voltage rise. Failure to do may damage the equipment and void warranty.

For guidance see AS / NZS 5033 4.2 PV array maximum voltage.

The maximum Voltage Open Circuit for this equipment is 380 Vdc.

For example, if the lowest recorded temperature is 4 to 0 degrees C and the VOC of a module is 44.2 Vdc, one would multiply 44.2 by 1.1 equalling 48.62 volts.

Adding 44.2 and 4.42 equals the low temperature VOC of 48.62.

Dividing the maximum VOC input of 380 Vdc by 48.62 yields the maximum number of solar modules 7.81. Rounding down yields 7 modules max at that low temperature.

From AS / NZS 5033 4.2 PV array maximum voltage.

VOLTAGE CORRECTION FACTORS FOR CRYSTALLINE AND MULTI-CRYSTALLINE SILICON PV MODULES

Lowest expected operating temperature °C	Correction factor
24 to 20	1.02
19 to 15	1.04
14 to 10	1.06
9 to 5	1.08
4 to 0	1.10
-1 to -5	1.12
-6 to -10	1.14
-11 to -15	1.16
-16 to -20	1.18
-21 to -25	1.20
-26 to -30	1.21
-31 to -35	1.23
-36 to -40	1.25

Galvanic considerations outdoor unit.

The outdoor unit is to be treated as a non-galvanically isolated regulator. The solar isolation switches must be rated for the full array voltage and current. If connected to the AC supply, the outdoor unit must be connected to the 230-volt AC distribution board via a type A or B residual current and overcurrent device.

Solar Module installation

This manual contains information regarding the installation and safe handling of solar photovoltaic module(s). All instructions should be read and understood before attempting to install. If there are any questions, please contact our sales department for further explanation. The installer should conform to all safety precautions listed in this guide when installing the modules. Local codes and regulations must be followed.

Solar Arrays in Parallel

If it is desired to use smaller solar panels in parallel arrays the maximum number of arrays is 2. Additional paralleled arrays may not improve, performance, and may cause the arrays or the air conditioner to be damaged.

Solar Array maximum current.

The solar array maximum current is 18 amps.

This manual does not describe specific structures and installation procedures.

An approved solar technician must be consulted to determine the following:

- The specifications of the solar photovoltaic system
- Cable material
- Connecting components
- Bracket and support
- Supporting parts
- Switching and circuit protection



Solar modules are large and require careful handling. Only a qualified technician should install Solar Modules. Solar arrays are current limited sources. Use appropriate protection measures when working on them. They contain hazardous DC voltages.

Installation of Solar Modules should be performed only by qualified persons, who are familiar with the mechanical and electrical requirements.

All electrical connections should be made with approved MC-4 type connectors, and from the same manufacturer. (AS / NZS 5033 clause 4.3.7 (k))

One individual solar module generates DC voltage greater than 30V when exposed to sunlight. Contact with a DC voltage of 30V or more is potentially hazardous. Do not touch the contacts of electrical terminals.



Do not touch the module contacts.

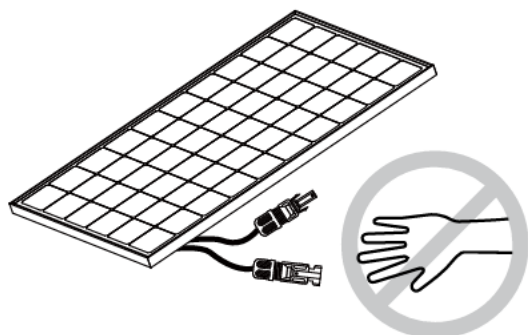

Keep children away from the system while transport and installing mechanical and electrical components.

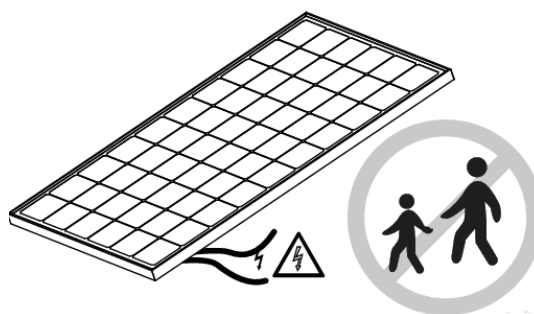

Completely cover the module with an opaque material during installation to keep electricity from being generated. Do not touch the ends of live wires. Do not wear metallic rings, watchbands, ear, nose lip rings or other metallic devices while installing or troubleshooting photovoltaic systems.

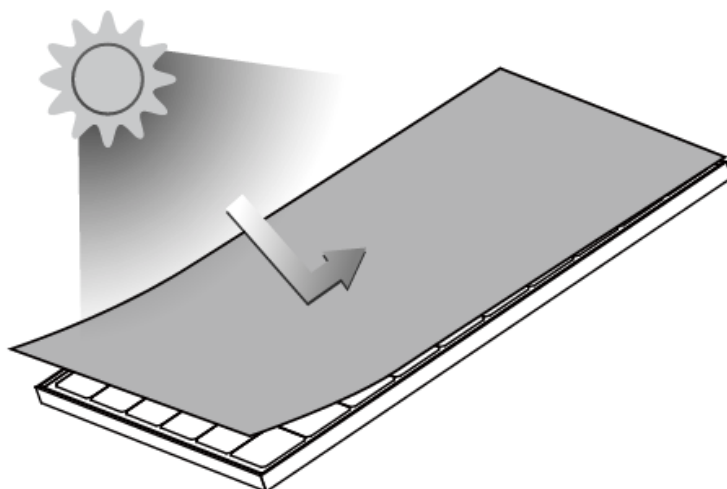

Use only insulated tools that are approved for electrical installations.

Do not work on solar modules in wet conditions.

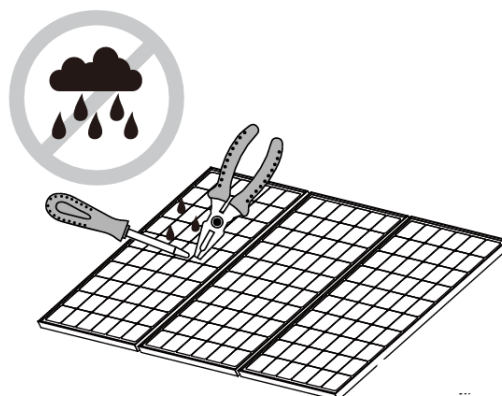
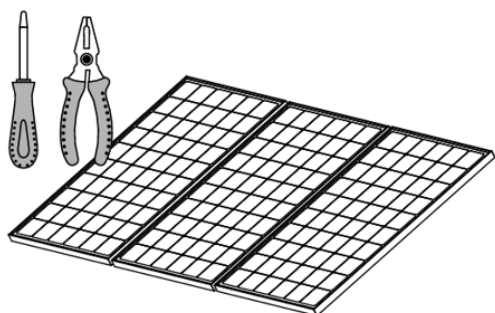

The module frame must be properly earthed. Removal on any one module must not interrupt the earthing of the remaining modules.

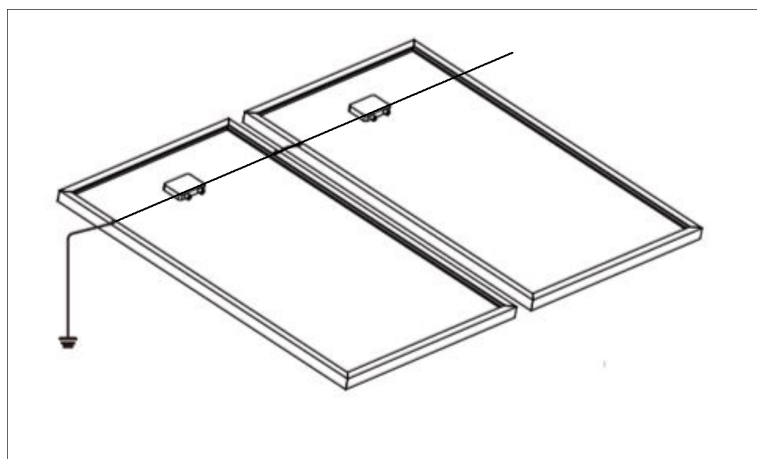

Solar Array Mechanical installation

Selecting an installation place:

- Select a suitable place for installation of the solar modules. The modules should not be shaded during the solar window part of the day.
- The module should be facing north in the southern latitudes for best power generation.
- An approved solar technician should be consulted to determine the best orientation of the solar panels.

Selecting the proper support frame:

- Always observe the instructions and safety precautions included with the support frame to be used with the modules.
- Never attempt to drill holes in the glass surface of the module. It will void the warranty.
- Do not drill additional mounting holes in the frame of the module. It will void the warranty.

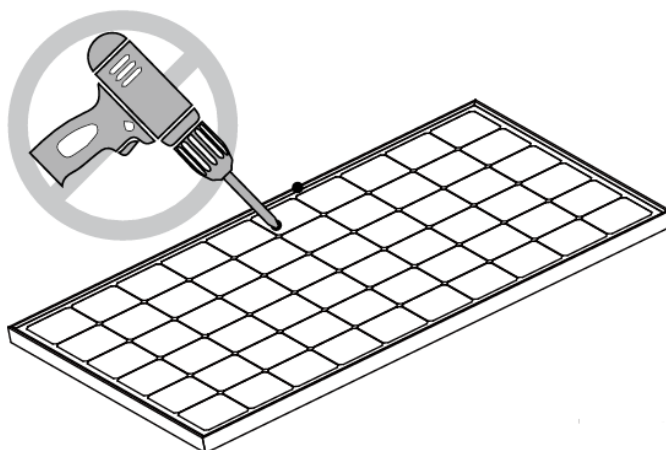

- Modules must be securely attached to the mounting structure using four mounting points for normal installation. If additional wind or snow loads are considered for the installation additional mounting points should also be used.
- The support frame must be made of durable, corrosion resistant and UV resistant material.
- The heat expansion and cold contraction of the support frame should have no effect on its usage and performance.

Ground mounting:

Select the height of the mounting system to prevent the lowest edge of the module from being covered by snow in winter in areas the experience heavy snowfalls. In addition, assure the lowest portion of the module is placed high enough that it is not shaded by plants or trees and is free from the effects of sand and stone driven by wind.

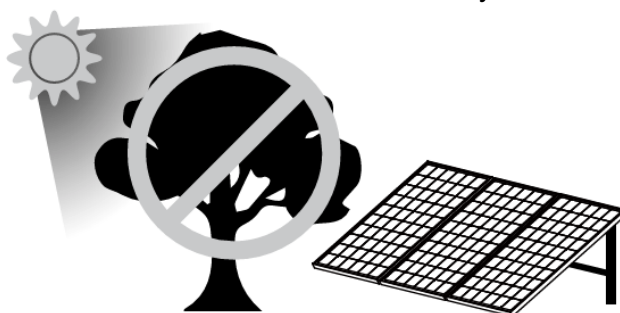

Roof Mounting:

When installing the modules on a roof ensure that they are securely fastened and cannot fall because of wind or snow loads.

When installing on a roof, ensure that the roof construction is suitable. In addition, any roof penetration required to mount the module must be properly sealed to prevent leaks.

The roof installation of solar modules may affect the fireproofing of the house construction and it may be necessary to use an earth ground fault circuit breaker.

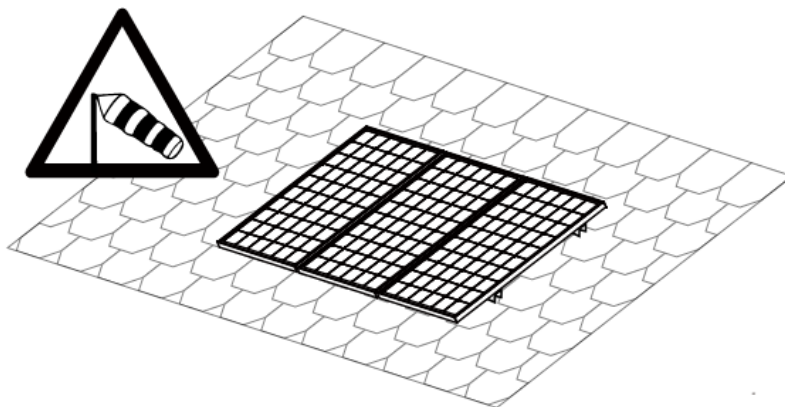

- Provide adequate ventilation under a module for cooling. 50 mm minimum between the module and the mounting surface.

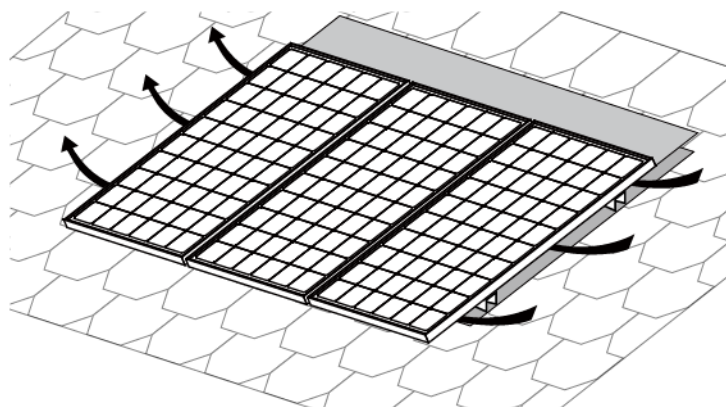

Pole mounting:

When installing the modules on a pole, choose a pole and module mounting structure that will withstand anticipated winds for the area. The pole must have a solid foundation.

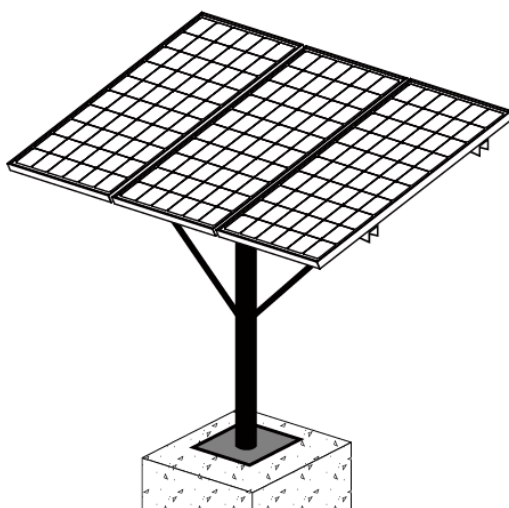



Solar Array Wiring

The array is formed of modules in series. The switch disconnectors must be approved for disconnecting solar DC under load.

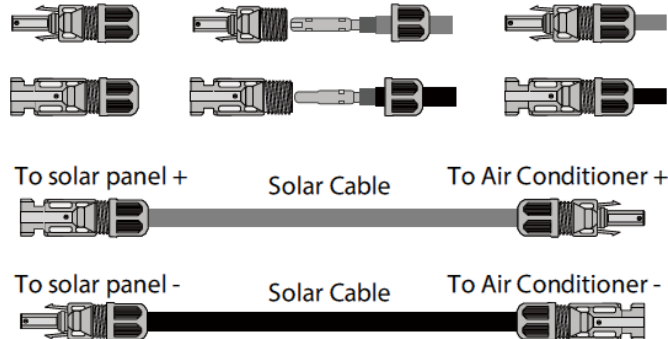

The MC 4 connectors must be approved and from the same manufacturer at each join. Mismatching connectors can cause failure and possible fire.



General installation:

- Do not use modules of different configurations in the same system.
- The solar array total system voltage must not exceed 380 volts DC open circuit. If installed in an area that experiences temperatures lower than 20 degrees C the Voltage open circuit will rise and a calculation must be done by a qualified technician.
- Both sides of an MC 4 type connection must be of the same type and manufacturer.
- Multistrand solar wire, having a minimum cross section of 2.5 sq mm or larger must be used.
- Cable installation must comply with all local and national codes and regulations.
- A switch disconnector rated for DC must be used between the array and the outdoor unit. If not adjacent to the array a separate switch must be installed at the array.

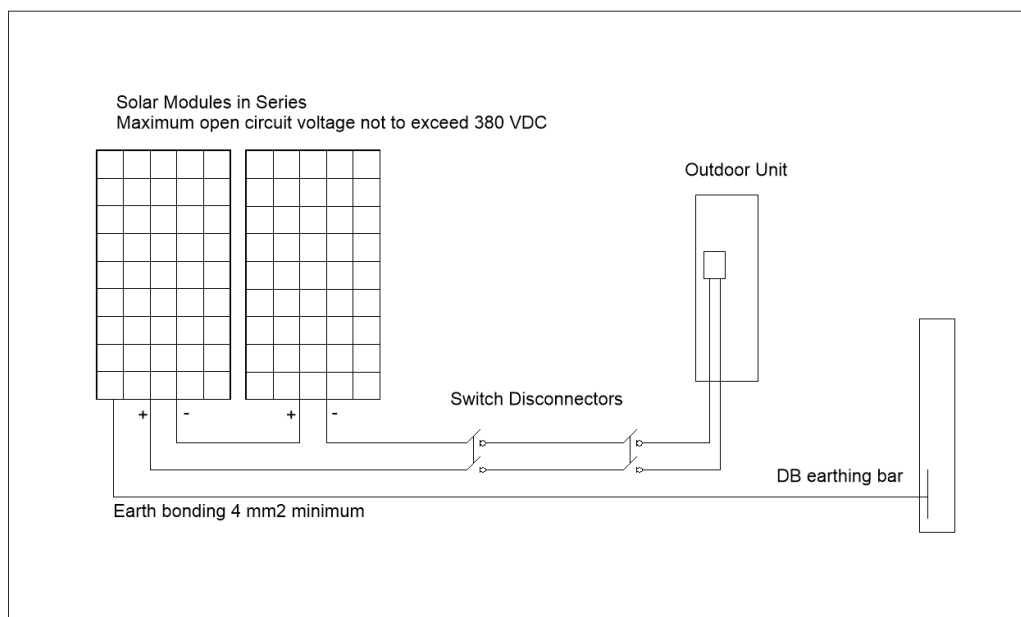

Earth Fault Protection Solar DC

The outdoor unit solar controller has DC earth leakage detection. When the PV positive and PV negative currents are not equal relays RY1 & 2 will open and disconnect DC power to the Unit.

An error code will be displayed on the outdoor unit AC/DC booster LED. The LED will flash 7 times.

Signage

Additional Solar signage to be posted on the outdoor unit.

**Warning Multiple Supplies
Isolate all supplies before working
on this Air Conditioner**

To be posted adjacent to the AC and DC isolating Switches.

**PV ARRAY
DC ISOLATOR**

**AC
ISOLATOR**

**Emergency
Air Conditioner Shutdown
Call 000**

1. If possible, turn off the DC isolator.
2. If possible, turn off the AC isolator.
3. Turn off all remaining DC and AC circuit breakers and switches in any order.
4. Turning off Breakers and Switches does not De-energize the solar array.

To be placed in the Distribution board.

Air Conditioner SOLAR ARRAY location _____

Short Circuit Current _____ **A**

Open Circuit Voltage _____ **V**

AIR CONDITIONER SHUT DOWN START UP PROCEDURE

Shut down

- 1. Turn off air conditioner at wall mounted touchpad**
- 2. Turn off AC and DC isolators.**

Start Up

- 1. Turn on AC and DC isolators**
- 2. Turn on air conditioner with remote control.**

**WARNING: PV ARRAY D.C. ISOLATORS
DO NOT DE-ENERGIZE THE
PV ARRAY AND ARRAY CABLING**

[Solar Disclaimer](#)

Because the use of this manual and conditions or methods of installation, operation, use and maintenance of the photovoltaic (PV) product are beyond our control, we do not take any responsibility and expressly disclaim liability for loss, damage, or expense arising out of or in any way connected with such installation, operation use or maintenance. Nor responsibility is assumed by us for any infringement of patents or other rights of third parties, which may result by using the PV product. No license is granted by modification or otherwise under any patent or patent rights.

The information in this manual is based on company knowledge and experience and is believed to be reliable, but such information including product specification (without limitations) and suggestions do not constitute a warranty, expressed or implied.

We reserve the right to change the manual, the PV product, the specifications, or product data sheets without prior notice.

Electrical and Gas Leak checks.

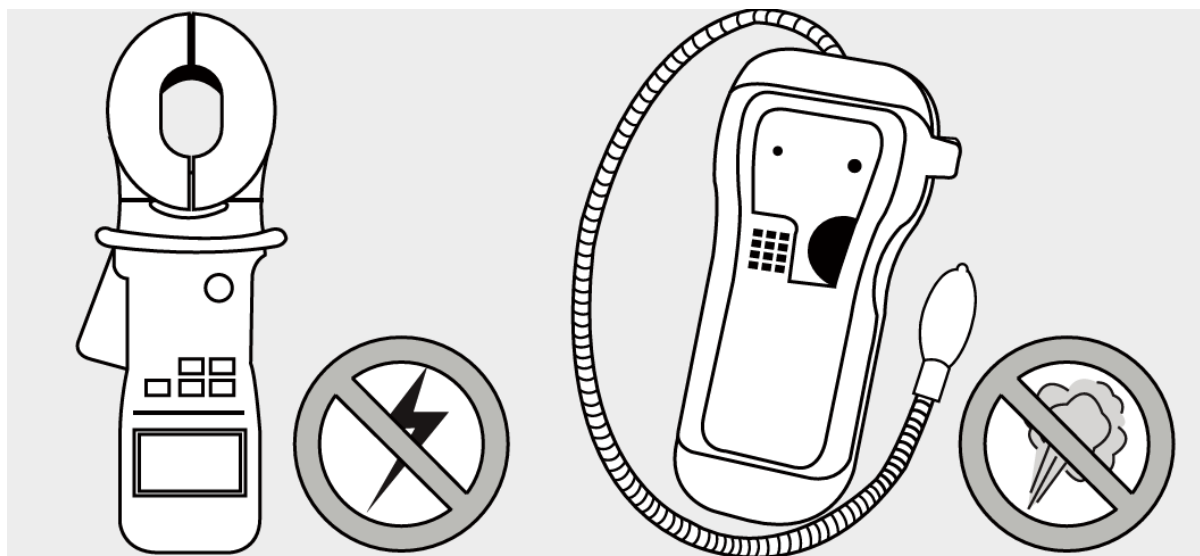

Gas Leak checks

Prior to the test run check for gas leaks using the following methods:

Soap and water method

Using a soft brush, apply soapy water or liquid detergent to all pipe connection points on the indoor and outdoor unit. The presence of bubbles indicates a leak. Repairs must be made prior to test running the unit.

Leak Detector method

If using a leak detector, refer to the device's operation manual for proper usage instructions.

Electrical Safety checks

After installation, confirm that all electrical wiring is installed in accordance with local and national regulations, and according to the installation manual.

Before the test run:

Verify earthing of the air conditioner and the solar array.

Measure earthing resistance. The earthing resistance must be less than required to trip any protection devices.

Perform an insulation resistance test.

During the test run:

Check for electrical leakage, using a low current tong meter. Test Run

Before the test run:

Verify that:

- The unit's electrical system is safe and will operate properly.
- The gas leak checks have been performed.
- Confirm that the low- and high-pressure valves are fully open.

The test should run for at least 30 minutes.

Connect power to the unit.

Press the On/Off button on the controller. The indoor unit will respond.

Press the MODE button to scroll the functions one at a time:

COOL – Select the lowest temperature. Allow to run for 5 minutes.

HEAT – Select the highest possible temperature. Allow to run for 5 minutes.

After the Test Run is completed, return the unit to normal operating temperature.

Wrap the pipe connections with insulation.

Commissioning checklist

Commissioning Check list			
Checks to be performed	Pass	Fail	Notes
Solar Array Voc maximum less than 380 Volts. Must be compensated for temperature			
Solar array earthed			
Solar array operating current test			
AC and DC leakage test			
Indoor and outdoor unit earthed			
All electrical connections proper and secured			
All pipe connections leak tested			
Water drains properly Condensate pump working if installed			
Piping properly insulated			
Test Cooling function			
Test Heating function			
Eco Mode limits AC input current			

Maintenance

Each year:

Indoor unit:

Turn off the air conditioner.

Remove and clean or replace air filters.

Outdoor unit:

Check that the outdoor unit airflow is not obstructed by objects on or around it, and vegetation.

Examine the general condition of the outdoor unit.

Check the fan for foreign objects.

Check the fins for deformation.

Check the insulation of the piping for security and integrity.

Remove Vegetation that is shading the solar modules.

Clean Solar modules in accordance with manufacturers recommendations.







The following must be carried out by qualified person(s)

Replace damaged insulation.

Check the condition of electrical conduits. Replace any damaged wiring or conduits.

Operating Instructions

Following the instructions below will allow you to get the best from your air conditioner

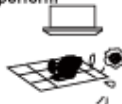
Proper use method	
<p>● During cooling, avoid direct sunshine Please close the curtains</p> 	<p>● Do not obstruct air flow Do not place objects near the air inlet or outlet of either the indoor or outdoor unit. If the air flow is obstructed then the air conditioner will be unable to perform correctly.</p> 
<p>● Try not to cool excessively Suggestion of setting temperature: Cooling: 26~28℃ Heating: 18~22℃ Dehumidify: 20~24℃</p> 	<p>● Do not use other heating equipment when unit run cooling function Using heating equipment will affect the cooling effect.</p> 
<p>● Keep the windows or doors shut Open windows or doors will increase the amount of heating or cooling required and may prevent the unit being able to perform correctly</p> 	<p>● Clean the air filter regularly Dirty filters will prevent the unit from being able to perform correctly and may cause expensive damage. Clean regularly by washing or with a vacuum cleaner. Replace if necessary. We recommend filter cleaning once a month or more frequently if required.</p> 

⚠ Caution

- Before Cleaning the air filter stop the unit on the controller and turn off at the power supply.
- Do not clean the air conditioner with water or you risk both electric shock and short circuit.
- When cleaning the air filter ensure you pay attention to health and safety.



★Cleaning the Air Filter

In order to ensure the best performance from your air conditioner clean the air filter regularly
We recommend cleaning once a month or more frequently if required.

1. The filter can be cleaned using a vacuum cleaner or with soap and water.
2. Take off the air filter
 - ① First, take off the bolt casing on the air inlet grille, then take off the bolts using the screwdriver, and take off the filter net.
 - ② Set the filter net back to the air inlet grille, fix its bolt and the casing.



⚠ Caution

- When the filter is very dirty it can be washed in detergent and hot water (below 45℃).
- Ensure the filter is fully dry before reinstallation to avoid risk of electric shock or short circuiting.
- Do not dry the filter using direct sunlight.

Wired Control operation

Display and functions:

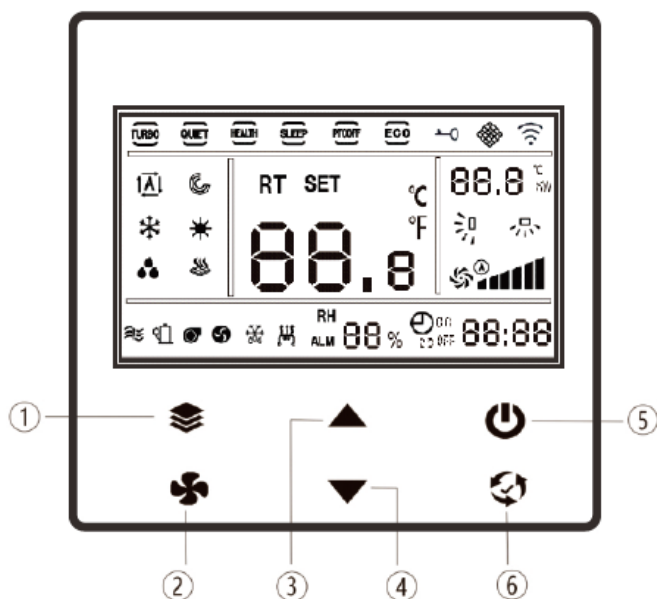

Button Functions		
1	Parameter Setting / Timing	<ol style="list-style-type: none"> Short press to enter timing mode. Long press >5 seconds to enter parameter setting mode
2	Fan Speed / Time Setting	<ol style="list-style-type: none"> Short press to adjust fan speed. Long press > 5 seconds to enter fan speed time setting. Press mode key (6) to return.
3	UP	Increase or decrease set temperature, set time, parameters or display serial number.
4	DN	
5	On / Off	Turns the air conditioner on or off.
6	Mode	Short press to switch modes. Modes are: <ul style="list-style-type: none"> • Auto • Cooling • Dehumidify • Fan • Heating

Detailed Wired Control operation

On off:

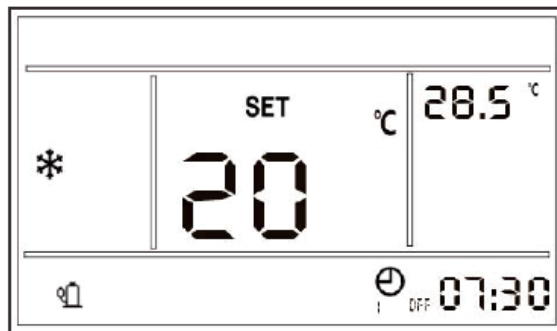

On Display



Off Display

Short press of the on off button (5) starts and stops the unit.

Modes

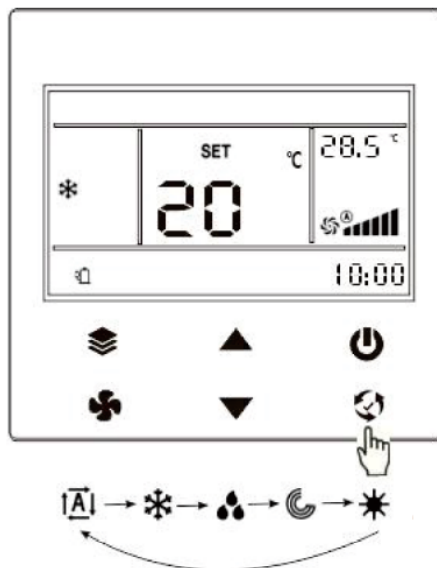

The mode button cycles through from Auto to Heating and back to Auto.

Set Temperature

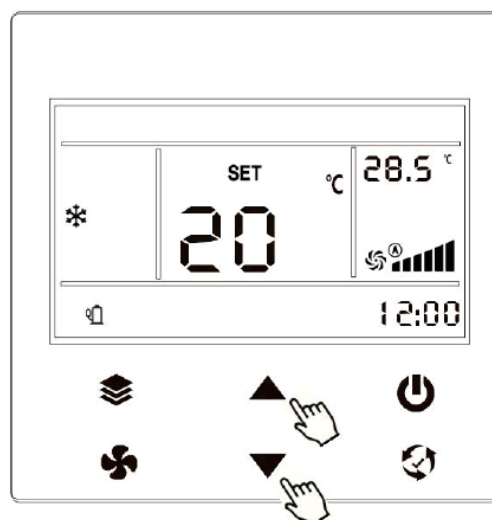

Select the desired mode and using the UP and DN buttons set the desired temperature.

Set Time.

Press and hold the Fan button for 5 seconds.

The time display will flash on and off at a 1 second rate.

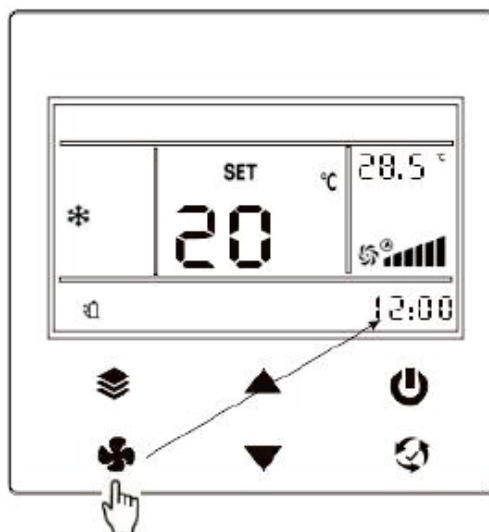

Press the UP or DN button to change the time.

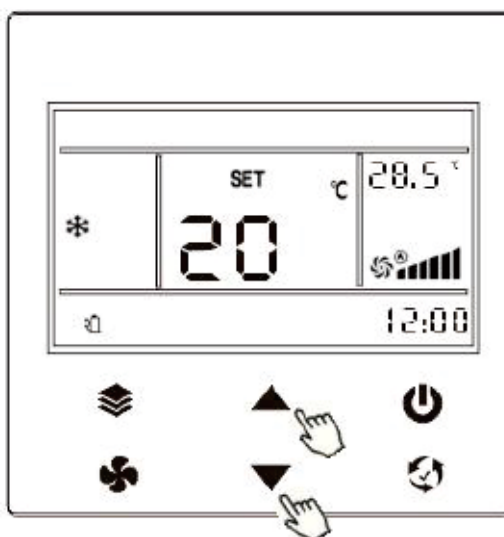

When the desired time has been set press the mode button to exit.

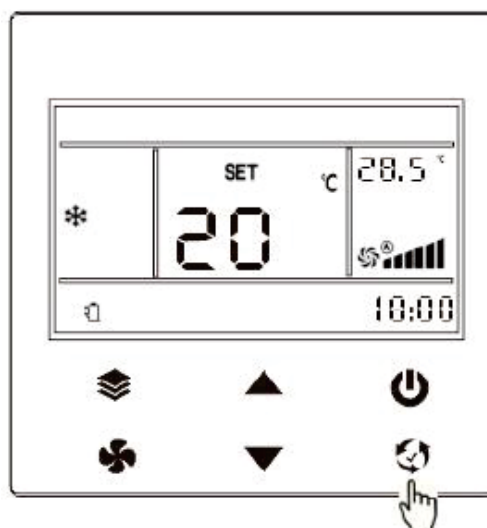

Timing Periods

The wired control can set up to three timing periods per day.

Setting:

Short press the (1) Parameter Setting / Timing button. The first timing period will blink. Pressing the (1) Parameter Setting / Timing button again will cycle through the timing periods.

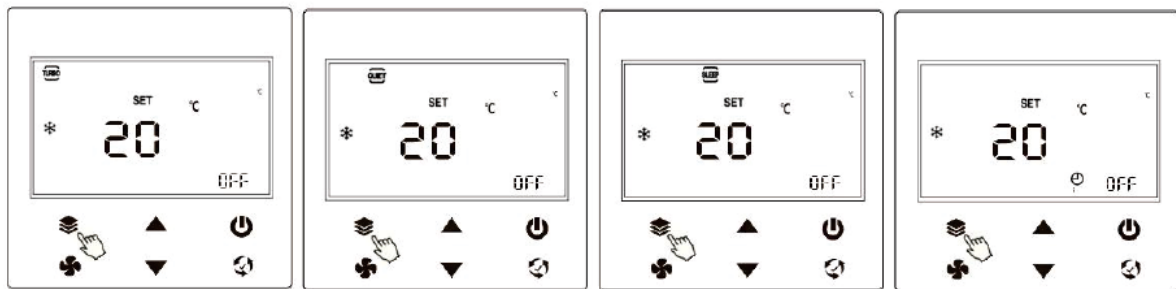

AC Limiting Mode note:

If timing period 1 is activated AC Limiting mode is enabled. In AC Limiting mode the use of utility power is restricted, and the air conditioner is primarily powered by solar power.

After setting the timing period(s) press the UP or DN Buttons to enable / disable the timing period.

After selecting the timing period and setting it to ON, short press the Mode button (6) to set the start time, and stop time, using the UP and DN buttons. Press the Parameter Setting / Timing button (6) to exit.

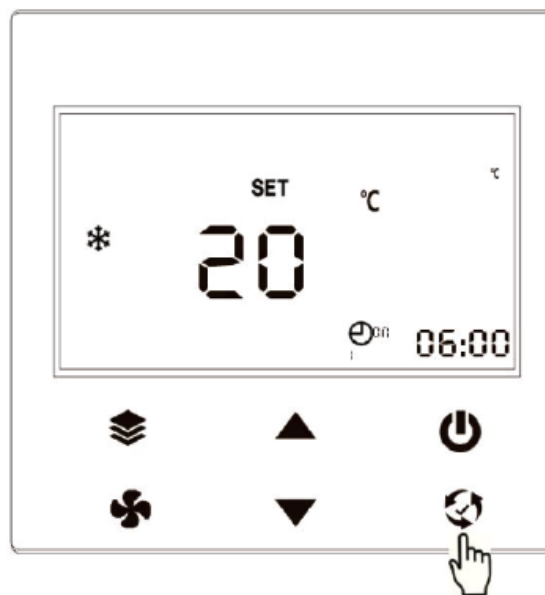

The timing period that is being executed is displayed in the lower right of the display.

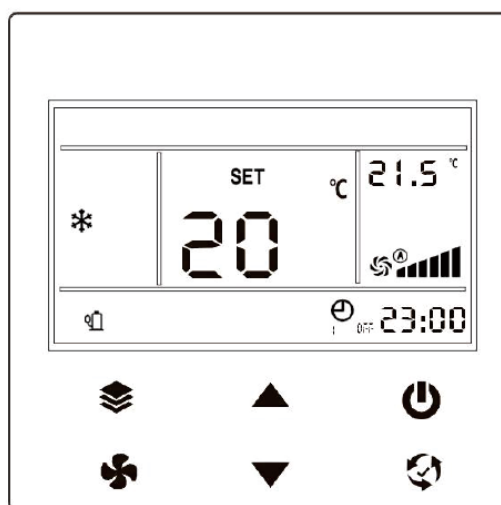

AC Limiter Mode Permanent setting

To permanently enable the AC limiter mode.

- Press parameter until Timer 1 is visible.
- Select up or down to turn timer 1 on.
- Press Mode to select on time.
- Set time to 0:00. Press Mode to confirm.
- Set off time to 23:59 Press mode to confirm.
- Check that Turbo is not automatically selected for the fan setting. Set fan setting to auto.
- AC Limiting Mode will now be selected.

Fault Display

Faults are displayed in the lower middle of the display. Fault F3 is being displayed in the below.

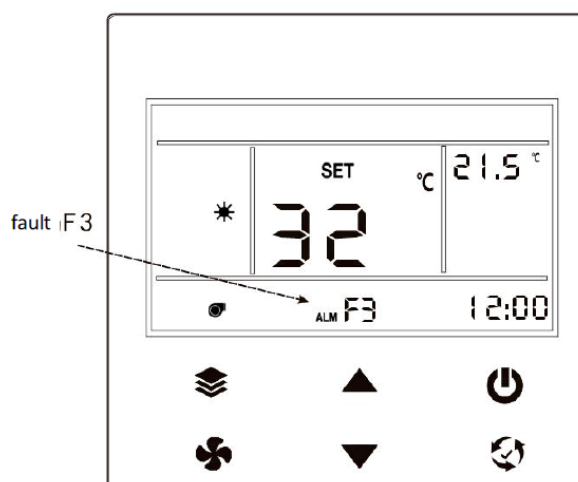

Android or I phone app.

Scan the QR code in the owners- manual.



1. Download the app.
2. Turn the air conditioner on.
 - Press the Parameter Setting / Timing button (1) until the WIFI icon flashes.
 - Press the Mode button (6)
 - If the connection is successful, the WIFI icon will change from flashing to steady on.
 - If the connection fails, the unit will revert to Bluetooth mode.

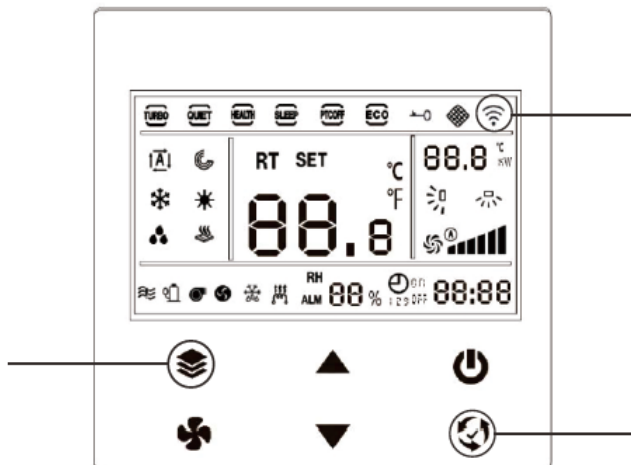

3. In the settings on your phone enable and connect to the home WIFI. Enable Bluetooth also.
4. Open the Solar Aircon app on and it should automatically detect the Solar air conditioner. Select Solar AC to add, tap go to add. Enter the home WIFI password and start the connection.

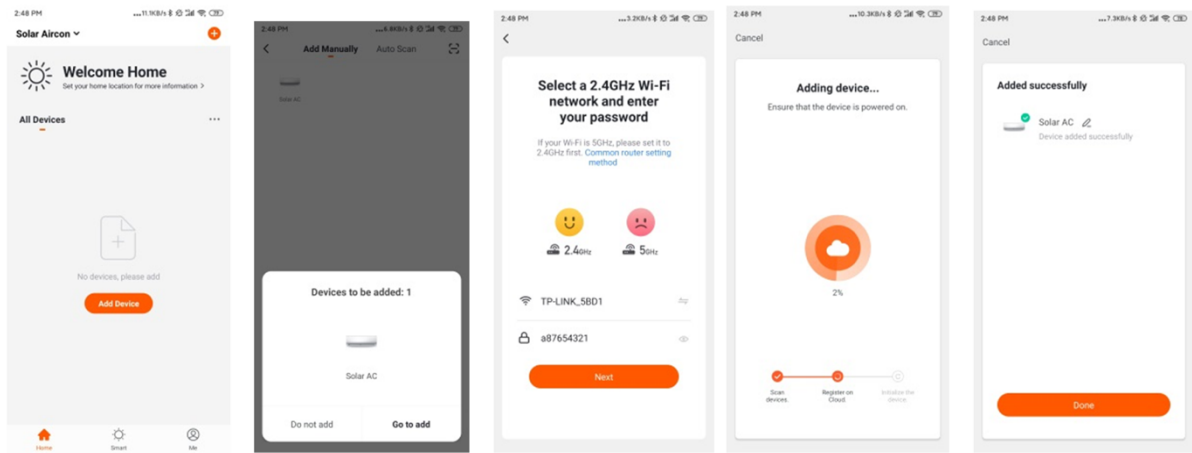

1. Use the app to control the air conditioner anywhere via WIFI. Observe the power saving data and view the power consumption by hour/day/month/year.

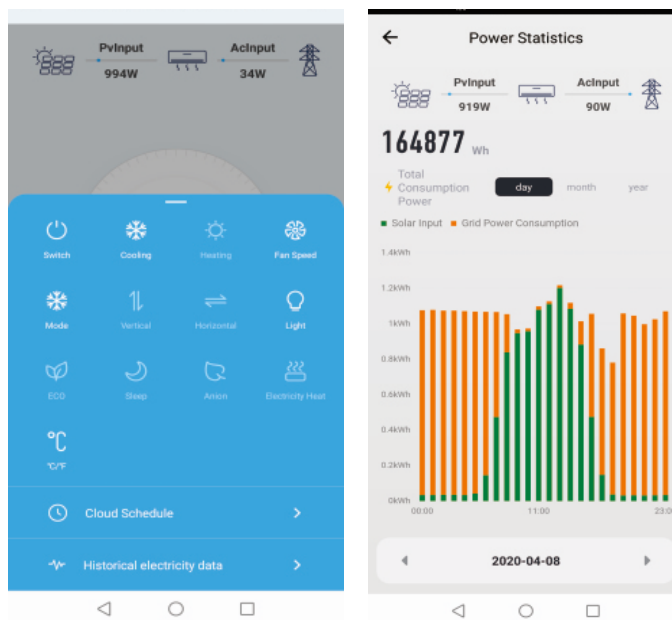

Troubleshooting and Repair

For Repair parts and service information contact

1300 46 22 32

acdc@solaracdc.com.au



Warning disassembly of the units can result in an electric shock hazard. This unit employs multiple sources of supply and care must be taken that all supplies are turned off and energy storage devices disconnected.

Common Issues.

Please check the following before contacting a repair company.

Issue	Possible Causes
Unit does not turn on when pressing the on off button	The Unit has a 3-minute protection feature that prevents the unit from overloading. The unit will not restart within three minutes of being turned off.
The unit changes from COOL/HEAT mode to FAN mode	The unit may change its setting to prevent frost from forming on the unit. Once the temperature increases, the unit will start operating in the previously selected mode again.
	The set temperature has been reached, at which point the unit turns off the compressor. The unit will continue operating when the temperature fluctuates again.
The indoor unit emits white mist	In humid regions, a large temperature difference between the room's air and the conditioned air can cause white mist.
Both the indoor and outdoor units emit white mist	When the unit restarts in HEAT mode after defrosting, white mist may be emitted due to moisture generated from the defrosting process.
The indoor unit makes noises	A rushing air sound may occur when the louver resets its position.
	A squeaking sound may occur after running the unit in HEAT mode due to expansion and contraction of the unit's plastic parts.
Both the indoor unit and outdoor unit make noises	Low hissing sound during operation: This is normal and is caused by refrigerant gas flowing through both indoor and outdoor units.
	Low hissing sound when the system starts, has just stopped running, or is defrosting: This noise is normal and is caused by the refrigerant gas stopping or changing direction.
	Squeaking sound: Normal expansion and contraction of plastic and metal parts caused by temperature changes during operation can cause squeaking noises.
The outdoor unit makes noises	The unit will make different sounds based on its current operating mode.
Dust is emitted from either the indoor or outdoor unit	The unit may accumulate dust during extended periods of non-use, which will be emitted when the unit is turned on. This can be mitigated by covering the unit during long periods of inactivity.
The unit emits a bad odour	The unit may absorb odours from the environment (such as furniture, cooking, cigarettes, etc.) which will be emitted during operations.
	The unit's filters have become mouldy and should be cleaned.
The fan of the outdoor unit does not operate	During operation, the fan speed is controlled to optimize product operation.
Operation is erratic, unpredictable, or unit is unresponsive	Interference from cell phone towers and remote boosters may cause the unit to malfunction. In this case, try the following: <ul style="list-style-type: none"> • Disconnect the power, then reconnect. • Press ON/OFF button on remote control to restart operation.

Problem	Possible Causes	Solutions
Poor Cooling Performance	Temperature setting may be higher than ambient room temperature	Lower the temperature setting
	The heat exchanger on the indoor or outdoor unit is dirty	Clean the affected heat exchanger
	The air filter is dirty	Remove the filter and clean it according to instructions
	The air inlet or outlet of either unit is blocked	Turn the unit off, remove the obstruction and turn it back on
	Doors and windows are open	Make sure that all doors and windows are closed while operating the unit
	Excessive heat is generated by sunlight	Close windows and curtains during periods of high heat or bright sunshine
	Too many sources of heat in the room (people, computers, electronics, etc.)	Reduce amount of heat sources
	SLEEP function is activated	SLEEP function can lower product performance by reducing operating frequency. Turn off SLEEP function.
	Solar power is not enough. grid power is off, air conditioner runs only on solar panels.	Turn on the grid power.
The unit is not working	Both solar and grid power is off	Turn on grid and solar power
	Remote control batteries are dead	Replace batteries
	Timer is activated	Turn timer off
Poor heating performance	The outdoor temperature is lower than 7°C (44.5°F)	Use auxiliary heating device
	Cold air is entering through doors and windows	Make sure that all doors and windows are closed during use

Problem	Possible Causes	Solutions
Error code appears in the window display of indoor unit: • E0, E1, E2... • P1, P2, P3... • F1, F2, F3...	The unit may stop operation or continue to run safely. If the indicator light continues to display an error code, wait for about 10 minutes. The problem may resolve itself. If not, disconnect both solar and grid power, then connect it again 2 minutes later. Turn the unit on. If the problem persists, turn off the unit and contact an authorized service centre	

AC/DC Booster Error Code

AC/DC Booster Error Code:

LED Flash Times	Error Description
1	Pv input voltage is too high
2	Pv input voltage is too low
3	Output voltage is too high
4	Output voltage is too low
5	DC voltage is too high
6	DC voltage is too low
7	Leakage Protection
8	Overcurrent protection

Error Code list

Fault name	error code (APP)	error code(Wire controller)	Remarks
Indoor parameter error	01	01	
Internal and external machine communication failure	03	03	
Indoor key stuck fault	04	04	
Outdoor parameter error	05	05	
Internal fan communication failure	06	06	
Wire controller communication failure	07	07	
PFC temperature sensor failure	18	18	
High-voltage switch disconnection protection (high-voltage over-high protection))	24	H4	
Low-voltage switch disconnection protection (low-voltage too low protection)	25	H5	
Indoor environment sensor failure	31	J1	
Indoor coil sensor failure	32	J2	
Outdoor air temperature sensor failure	35	J5	
Outdoor heat exchanger sensor failure	36	J6	
Exhaust temperature sensor failure	37	J7	
Indoor fan stall failure	51	L1	
Indoor drain pump failure	52	L2	
Compressor feedback failure	55	L5	
Refrigerant leakage failure	57	L7	X
Outdoor fan failure	58	L8	
Input current control failure	73	73	
Over /short voltage protection	76	76	X
PFC overcurrent	81	81	
IPM module high temperature	91	91	
Compressor lack of phase	92	92	
Compressor stall failure	93	93	
IPM module overcurrent	95	95	
Oil return failure protection	E0	E0	
Compressor low speed protection	E1	E1	